

Design. Uniqueness. Innovations

Technical support



MB-24CRHD



MB-32CRHD



Design. Uniqueness. Innovations

## MB series

Multi-user outdoor panels



1080P  
(2 MP)



EM-Marin

MB-12/16CRHD

MB-06CRHD



MB-08CRHD



Thank you for  
choosing our equipment

**SLINEX**

User manual

**SLINEX**

## Attention!



As a result of continuous upgrades and functionality improvements, technical characteristics of the device can be changed without any preliminary declaration. This manual can contain some inaccuracy or misprint. The owner reserves the right to make corrections to the information described in the user manual and device package. The last revision of this manual is available on [www.slinex.com](http://www.slinex.com)

## Safety instructions

Please read and keep that manual.

The device installation process should be carried out by the qualified specialists.

Use the device from the  $-40\text{ }^{\circ}\text{C}$  to  $+50\text{ }^{\circ}\text{C}$  ( $-40\text{ }^{\circ}\text{F}$  to  $122\text{ }^{\circ}\text{F}$ ), always keep it within that temperature range.

Installation surface should be free from vibration and impact influence.

Keep this device far from open sources of heat, such as radiators, heaters, and ovens.

The device can be installed near other electronic equipment in case if the temperature of the environment does not exceed previously mentioned range.

The device should be protected from the direct influence of the natural phenomena, such as direct sunlight, rain or snow.

Don't use aggressive or abradant detergent for the device surface cleaning.

Use soft wet cloth or tissues to remove strong dirt.

## Nature protection



Don't throw away the device with other industrial or nutritive trash if you see that symbol. Some regions have separation and recycling systems for the electronic equipment. Connect with local authorities to receive information about recycling of electronic equipment for your region.

## Rights and limitation of liability

All rights reserved. Any part of that document can not be published in any form, translated into other languages or reproduced in any way including electronic or mechanical.

Document recording and copying are strictly forbidden without owner permission.

## Table of contents

1. Package .....	3
2. Specification .....	3
3. Description .....	5
4. Units and connectors .....	6
5. Schematic diagrams .....	7
6. Installation .....	9
7. Wireless ID card reader settings.....	9
8. Limited warranty.....	11

## 1. Package

MB series outdoor panel – 1 pc.  
 Power supply – 1 pc.  
 Flush mount installation box – 1 pc.

Connection wires kit – 1 pkg.  
 Mounting screws and anchors – 1 pkg.  
 User manual – 1 pc.

## 2. Specification



**CAMERA**  
 1/3" CMOS with mechanical IR cut filter

**RESOLUTION**  
 1920x1080 px.

**VIDEO OUTPUT**  
 PAL / AHD-H 1080p (2 MP)

**VIEW ANGLE**  
 140°

**LOCK RELAY CONTINUOUS CURRENT**  
 2 A

**BACKLIGHT TYPE**  
 Infra-red, 1.5 m. distance

**POWER**  
 +12 V, 1000 mA power adapter in the kit

**WIRELESS CARDS**  
 EM-Marin, 1000 pcs. max.

**MOUNTING TYPE**  
 Flush mount

**UNIT / INSTALLATION BOX DIMENSIONS**  
 MB-06/08/24CRHD  
 253x130x45 mm / 243x117x51 mm  
 MB-12/16/32CRHD  
 376x130x45 mm / 366x117x51 mm

**WORKING TEMPERATURE**  
 -40 ... +50 °C (-40... +122 °F)

## 3. Description

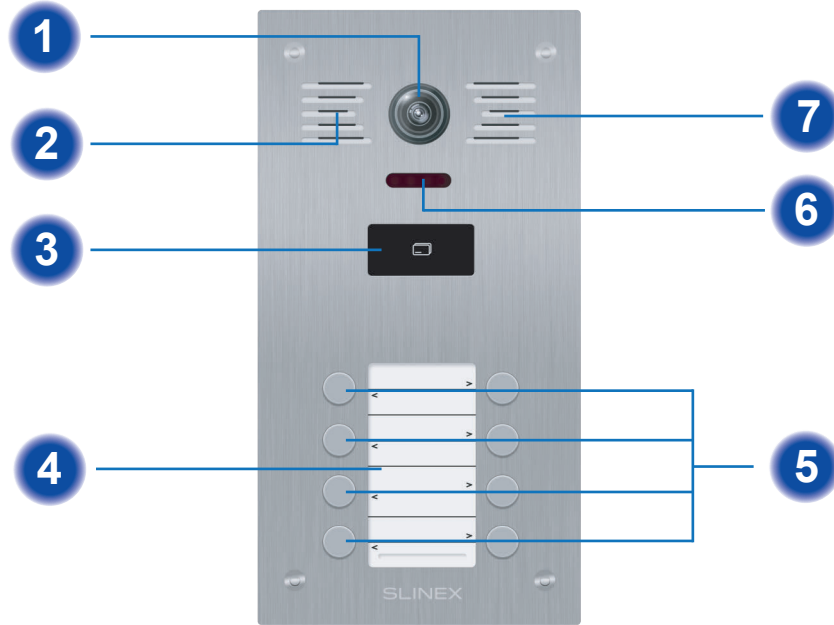

- 1 Video camera
- 2 Microphone
- 3 Wireless ID card reader
- 4 Name plates
- 5 Call buttons
- 6 Infrared night backlight
- 7 Speaker

## 4. Units and connectors

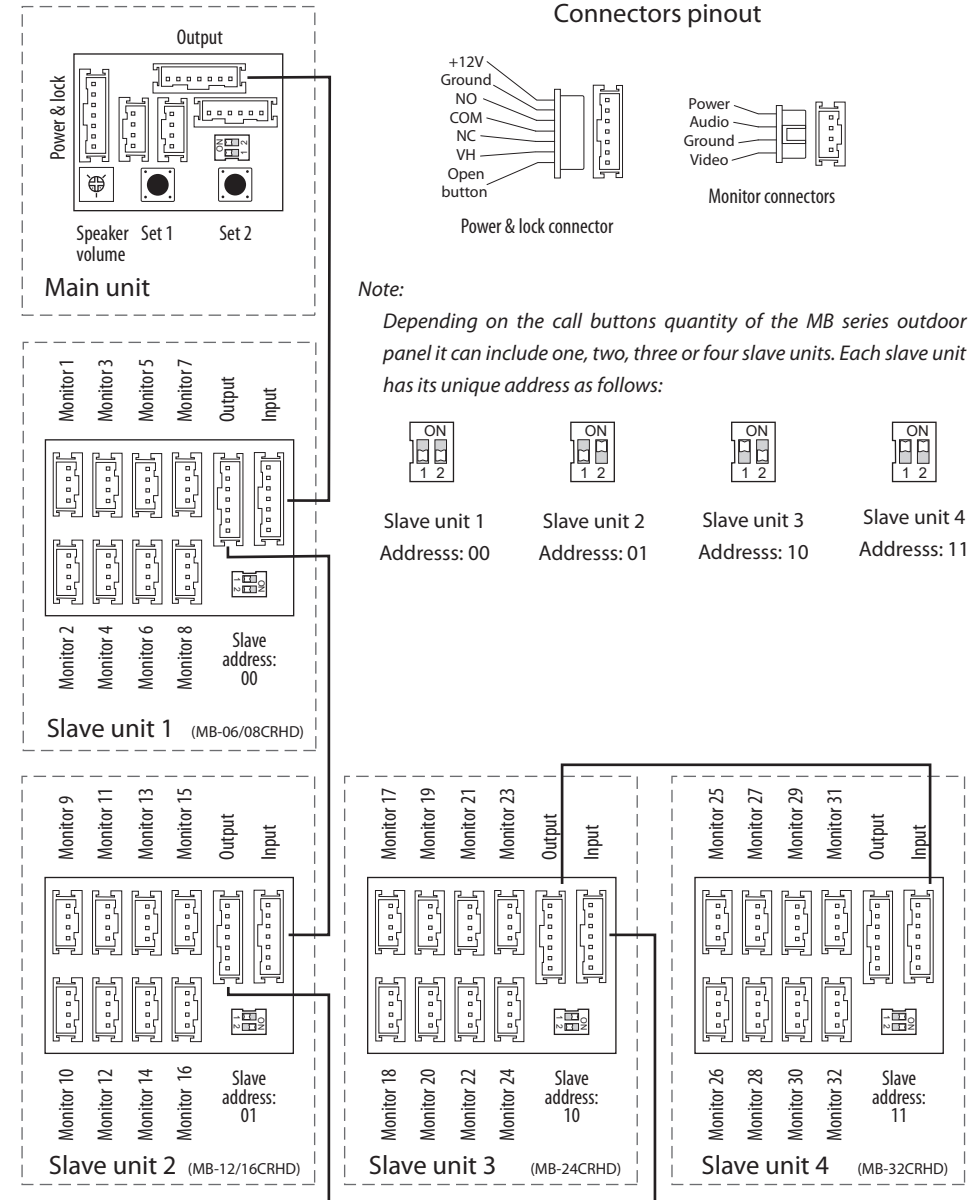

## 5. Schematic diagrams

Diagram 1. MB-08CRHD and eight monitors connection.

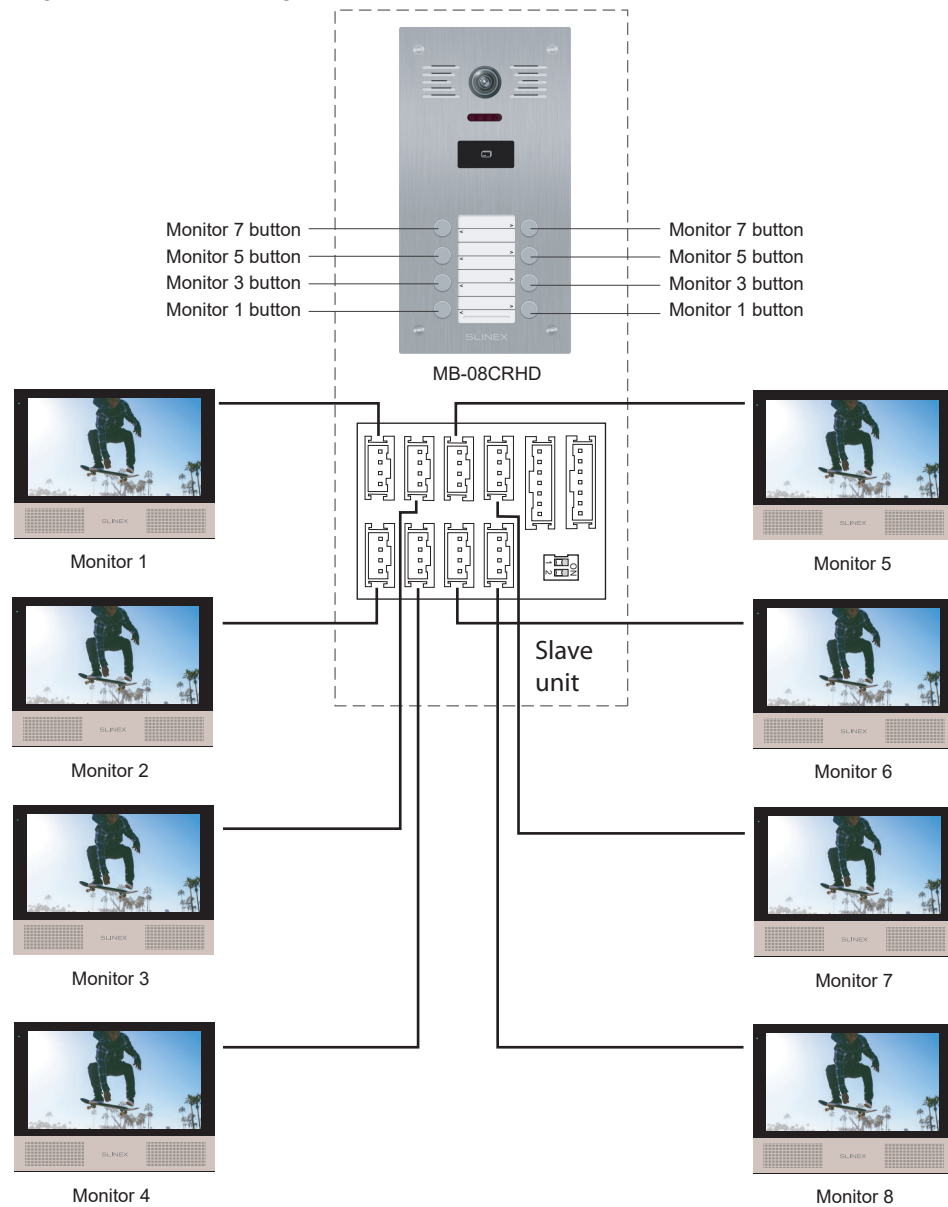

Diagram 2. Power supply and mechanical lock connection

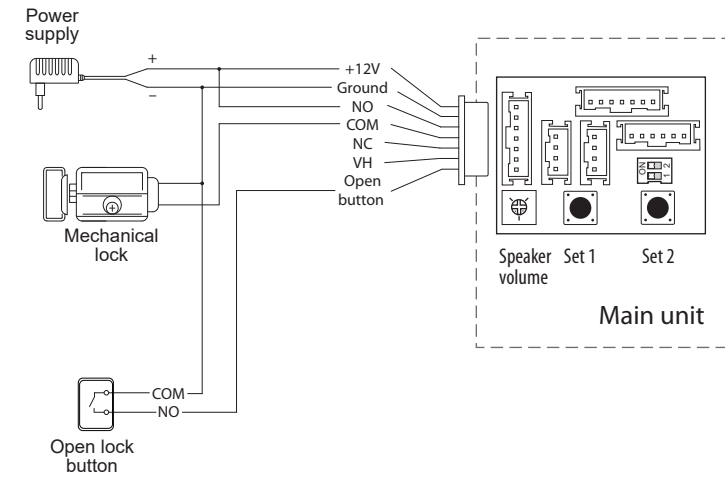
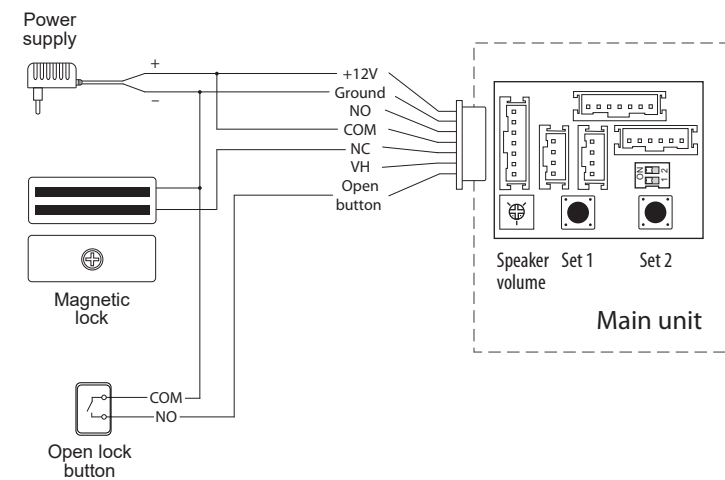
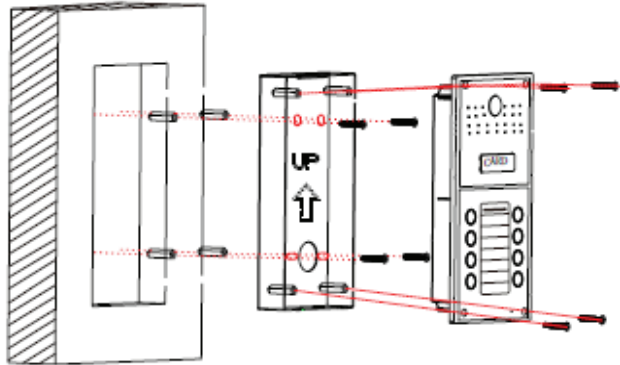

Diagram 3. Power supply and electromagnetic lock connection



## 6. Installation





### Outdoor panel flush mount process:



- 1) Prepare the hollow inside the wall according to the sizes mentioned on the 3rd page of the manual, 150-160 cm up from the floor line.
- 2) Mount flush mounting box into the hollow and fix it.
- 3) Connect all communication wires and insert the door panel inside the flush mounting box. Then fix it with four screws from the front side.

## 7. Wireless ID card reader settings

### Memory reset

1. Power off the outdoor station and turn the 1st and the 2nd switch on the main unit to "ON" position; 
2. Press and hold "Set1" and "Set2" button on the main unit and power on the outdoor station; 
3. After 3 seconds you will hear sound signal 7 times in a row. It means that memory reset is successful. Release "Set1" and "Set2" button on the main unit.

### Master ID card setup

1. Power on the outdoor station and turn the 1st switch to "ON" position and 2nd switch to "OFF" position; 
2. Press and hold "Set1" and "Set2" button on the main unit during 3 seconds to enter master card management mode; 
3. Swipe two ID cards near card reader. The first ID card is the master card for adding user ID cards. The second ID card is the master card for deleting user ID cards. Note that master cards can't be deleted by the "memory reset" procedure. They can only be replaced by adding new ID card following "master ID card setup" procedure.

### User ID cards adding

1. Swipe master card for adding user ID cards three times in 10 seconds. First an second time you will hear double "beep" sound from the outdoor panel, third time you will hear triple "beep" sound.
2. Swipe user ID cards to add them into the outdoor panel memory. You will hear double "beep" sound after successful adding of each ID card. If the ID card is already added to the outdoor panel memory and you will try to add it again then you will hear four "beep" sound four times.
3. Swipe master card for adding user ID cards one time or wait 60 seconds with no actions to exit into standby mode indicated with one time "beep" sound.

### User ID cards deleting

1. Swipe master card for deleting user ID cards three times in 10 seconds. First an second time you will hear double "beep" sound from the outdoor panel, third time you will hear triple "beep" sound.
2. Swipe user ID cards to delete them from the outdoor panel memory. You will hear double "beep" sound after successful deleting of each ID card. If the ID card is absent in the outdoor panel memory and you will try to delete it then you will hear four times "beep" sound.
3. Swipe master card for deleting user ID cards one time or wait 60 seconds with no actions to exit into standby mode indicated with one time "beep" sound;

## 11. Limited warranty

Manufacturer guarantees product normal functioning during the warranty period if the user keeps all safety instructions described in that manual.

Warranty period is 12 months from the moment of the product purchasing (warranty period could be extended up to 24 months or more, depending on the local regulations).

Warranty period allows the user to make guarantee repair in cases when normal functioning of the product was violated by the fault of the manufacturer and the user haven't offended transporting, installation and working conditions.

This limited warranty does not cover any damage the product that results from improper installation, accident, abuse, misuse, natural disaster, insufficient or excessive electrical supply, abnormal mechanical or environmental conditions, or any unauthorized disassembly, repair or modification.

The warranty does not cover following cases:

- the product was damaged by the fault of the customer;
- the product wasn't properly installed according to recommendations from the manual;
- the sticker on the backside of the product was broken;
- the product was not used for its intended function.

This limited warranty covers only repair, replacement, refund or credit for defective products, as provided above. The manufacturer is not liable for and does not cover under warranty, any damages or losses of any kind whatsoever resulting from loss of, damage to, or corruption of, content or data or any costs associated with determining the source of system problems or removing, servicing or installing products. This warranty excludes third-party software, connected equipment or stored data. The manufacturer is therefore not liable for any losses or damage attributable to the third party software, connected equipment or stored data.

In case a product has been discontinued, the manufacturer shall either repair the product, offer to replace it with a comparable product or provide a refund at the lesser of the purchase price or the product's current value.

Repaired or replacement products will continue to be covered by this limited warranty for the remainder of the original warranty term.