

Design. Uniqueness. Innovations

Technical support



Thank you for  
choosing our equipment

**SLINEX**

Design. Uniqueness. Innovations

# SQ-04

4" video intercom

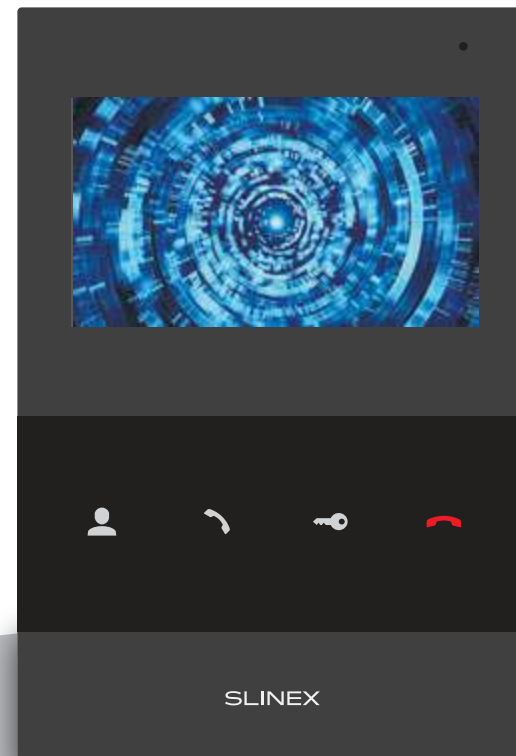

User manual

**SLINEX**

Attention!



As a result of continuous upgrades and functionality improvements, technical characteristics of the device can be changed without any preliminary declaration. This manual can contain some inaccuracy or misprint. The owner reserves the right to make corrections to the information described in the user manual and device package. The last revision of this manual is available on [www.slinex.com](http://www.slinex.com)

### Safety instructions

Read and keep that manual.

The device installation process should be carried out by the qualified specialists.

Use the device from -10 °C to +55 °C, always keep it within that temperature range.

Installation surface should be free from vibration and impact influence.

Keep this device far from open sources of heat, such as radiators, heaters, and ovens.

The device can be installed near other electronic equipment in case if the temperature of the environment does not exceed previously mentioned range.

The device should be protected from the direct influence of the natural phenomena, such as direct sunlight, rain or snow.

Don't use aggressive or abradant detergent for the device surface cleaning.

Use soft wet cloth or tissue to remove strong dirt.

Don't overpower outlets. It can cause fire or electric shock.

### Nature protection



Don't throw away the device with other industrial or nutritive trash if you see that symbol. Some regions have separation and recycling systems for the electronic equipment. Connect with local authorities to receive information about recycling of electronic equipment for your region.

### Rights and limitation of liability

All rights reserved. Any part of that document can not be published in any form, translated into other languages or reproduced in any way including electronic or mechanical.

Document recording and copying is strictly denied without owner permission.

### Table of contents

1. Package .....	3
2. Specification .....	3
3. Description .....	4
4. Installation .....	5
4.1. Cable requirements .....	5
4.2. Schematic diagram .....	6
4.3. Unit mount .....	7
5. Operation .....	8
5.1. Incoming call .....	8
5.2. Outdoor panel and camera monitoring .....	9
9. Limited Warranty .....	10

## 1. Package

SQ-04 indoor monitor – 1 pc.  
 Wall mounting bracket – 1 pc.  
 Connection wires – 1 pkg.  
 Mounting screws and nuts – 1 pkg.  
 User manual – 1 pc.

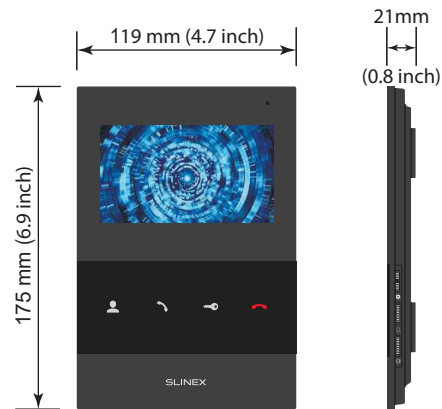

## 2. Specification

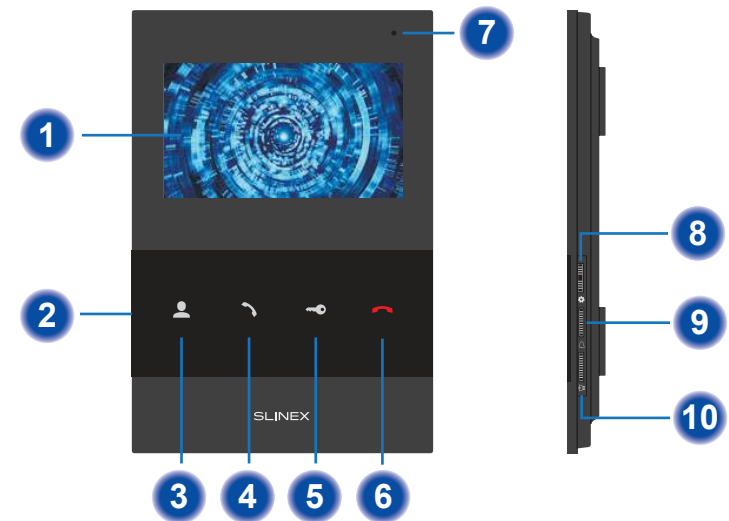

SCREEN 4.3", color TFT	STANDBY MODE POWER CONSUMPTION 1 W
RESOLUTION 480x272 px.	WORKING MODE POWER CONSUMPTION 6 W
VIDEO SYSTEM PAL / NTSC	POWER SUPPLY Built-in power supply, ~100–240 V
AUDIO TYPE Half duplex	MOUNTING TYPE Surface mount
CALL DURATION 120 seconds	DIMENSIONS 175x119x21 mm (6.89x4.68x0.83")
MEMORY No	WORKING TEMPERATURE -10 ... +55 °C (+14...+131 °F)

## 3. Description



- 1 Display;
- 2 Power switch;
- 3 «Monitor» button – door panel or camera image monitoring;
- 4 «Answer» button – incoming call answer and start talking with the visitor;
- 5 «Unlock» button – door unlocking;
- 6 «Hang Up» – stop conversation with the visitor;
- 7 Microphone;
- 8 Settings joystick 
  - press the joystick while monitoring or talking to enter brightness/contrast/chroma settings. Change current parameter by pressing joystick again;
  - move joystick up or down to change current parameter value;
- 9 Ring volume tuning slider  . Slide up to increase ring volume or down to decrease it;
- 10 Talking volume tuning slider.  Slide up to increase talking volume or down to decrease it.

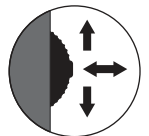

## 4. Installation

### 4.1. Cable requirements

Disconnect all power cables before device installation.

Cable type that is used for device connection depends on the distance between the last indoor monitor in the system and outdoor panel:

a) Use 4-wire cable with such parameters:

- distance up to 25 meters (82 ft.) use a cable with 0,22 mm<sup>2</sup> square of one wire (AWG 24);
- distance 25 to 50 (82-164 ft.) meters use a cable with 0,41 mm<sup>2</sup> square of one wire (AWG 21);
- distance 50 to 100 meters (164-328 ft.) use a cable with 0,75 mm<sup>2</sup> square of one wire (AWG 18).

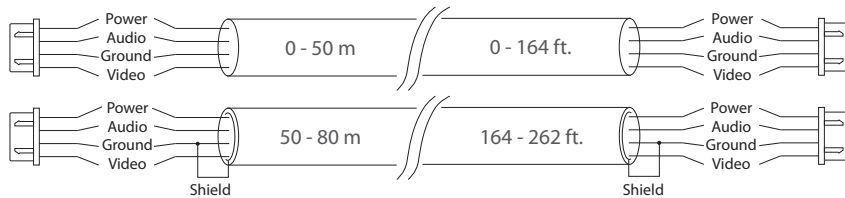

b) If the distance between door monitor and door panel is between 80 and 100 meters (262-328 ft.) then use a 3-wire cable with 0,75 mm<sup>2</sup> (AWG 18) square of one wire and RG-59 or RG-6 coaxial cable for the video signal.

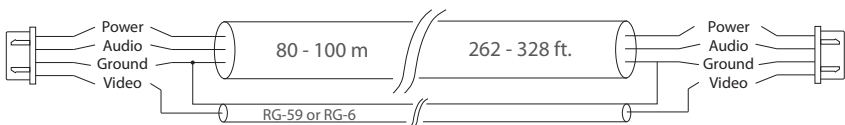

c) Shielded or non-shielded twisted pair (not recommended):

- distance up to 25 meters (82 ft.) non-shielded twisted pair can be used;

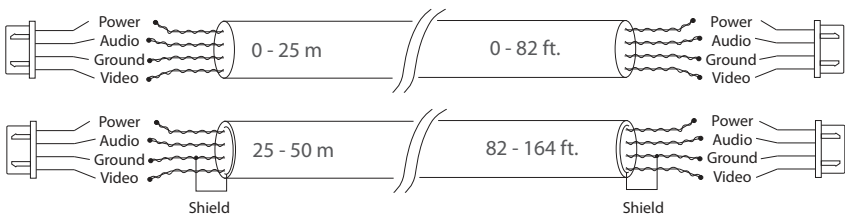

### 4.2. Schematic diagram

SQ-04 outdoor panels and locks connection.

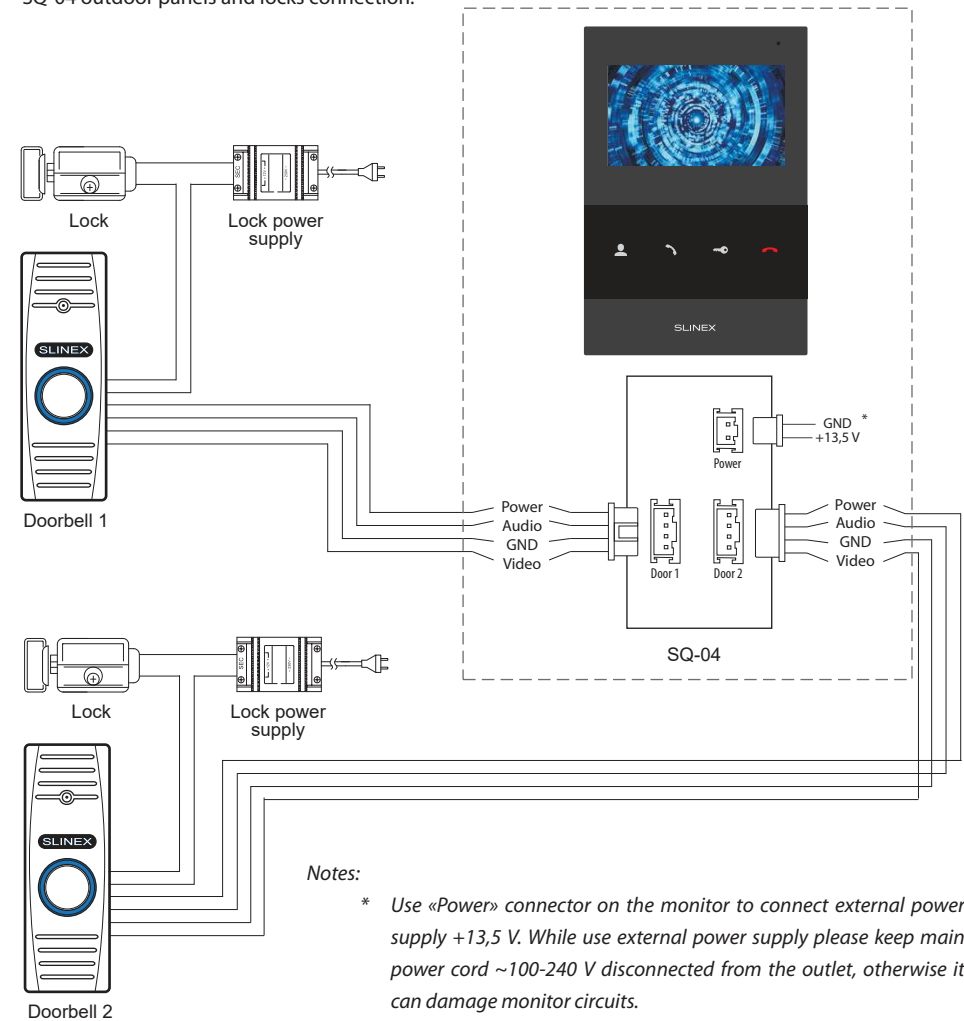

Notes:

\* Use «Power» connector on the monitor to connect external power supply +13,5 V. While use external power supply please keep main power cord ~100-240 V disconnected from the outlet, otherwise it can damage monitor circuits.

\*\* Door panels, power supplies and locks described on the scheme are optional devices and aren't included into monitors kit.

## 4.3. Unit mount

- 1) Take the surface mount bracket from the kit and place it 150-160 cm (approx. 5 ft.) from the floor line.
- 2) Mark and drill four holes in the wall.
- 3) Take four wall anchors from the kit and hammer them into the drilled holes.
- 4) Fix surface mount bracket on the wall by four screws from the kit.
- 5) Connect all communication wires and fix the monitor on the surface mount bracket.

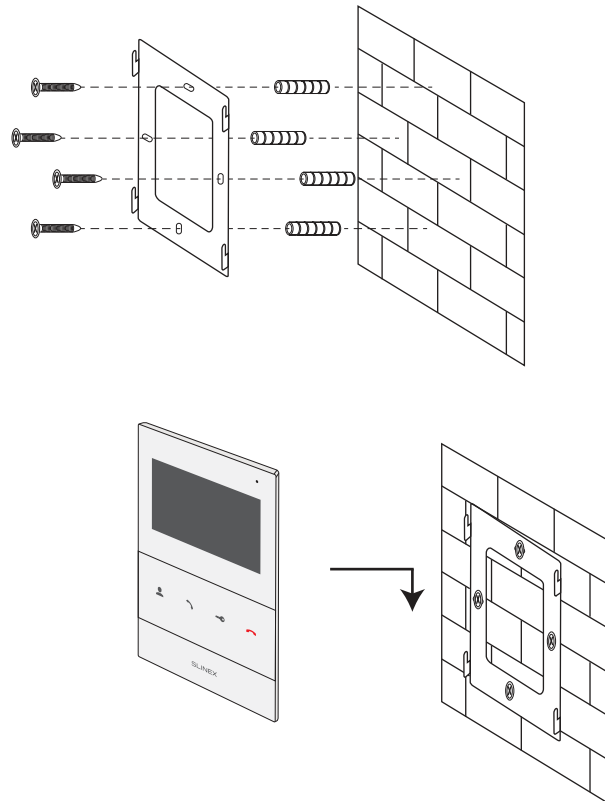

## 5. Operation

### 5.1. Incoming call

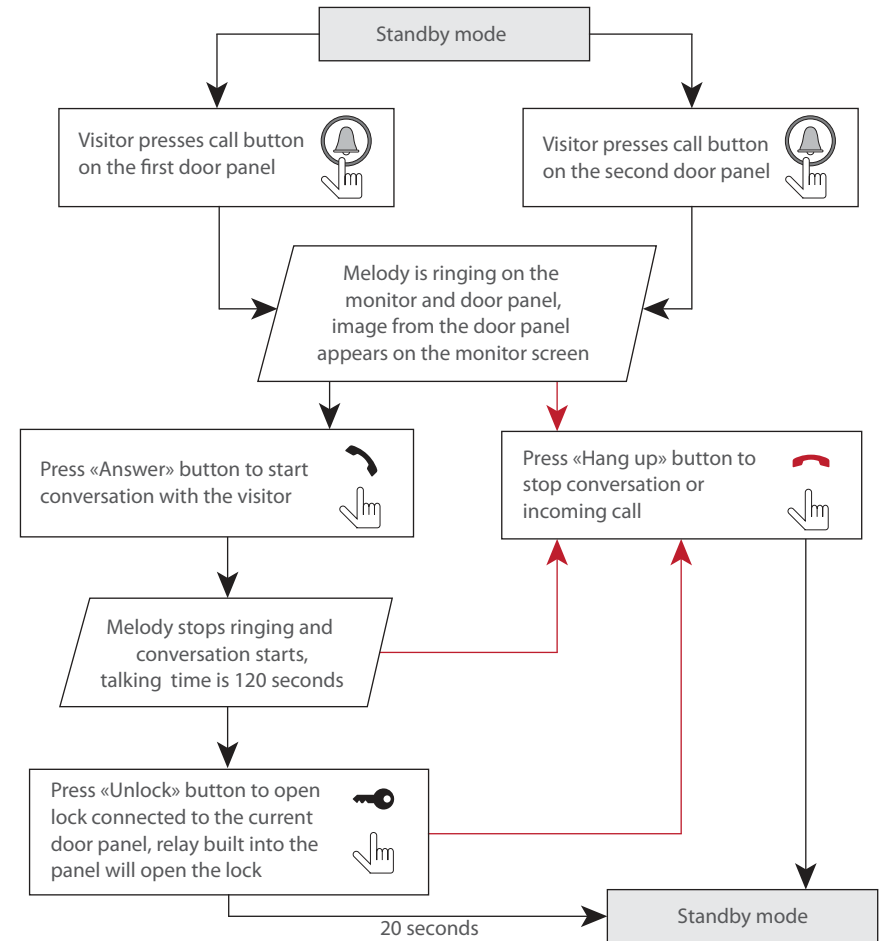

#### Notes:

- 1) Monitor will be automatically switched into standby mode if the user doesn't answer incoming call during 60 seconds;
- 2) Image and sound from the door panel will be active during 20 seconds after the moment user presses  button. It let the user know if the visitor passed through the door.

5.2. Outdoor panels image view

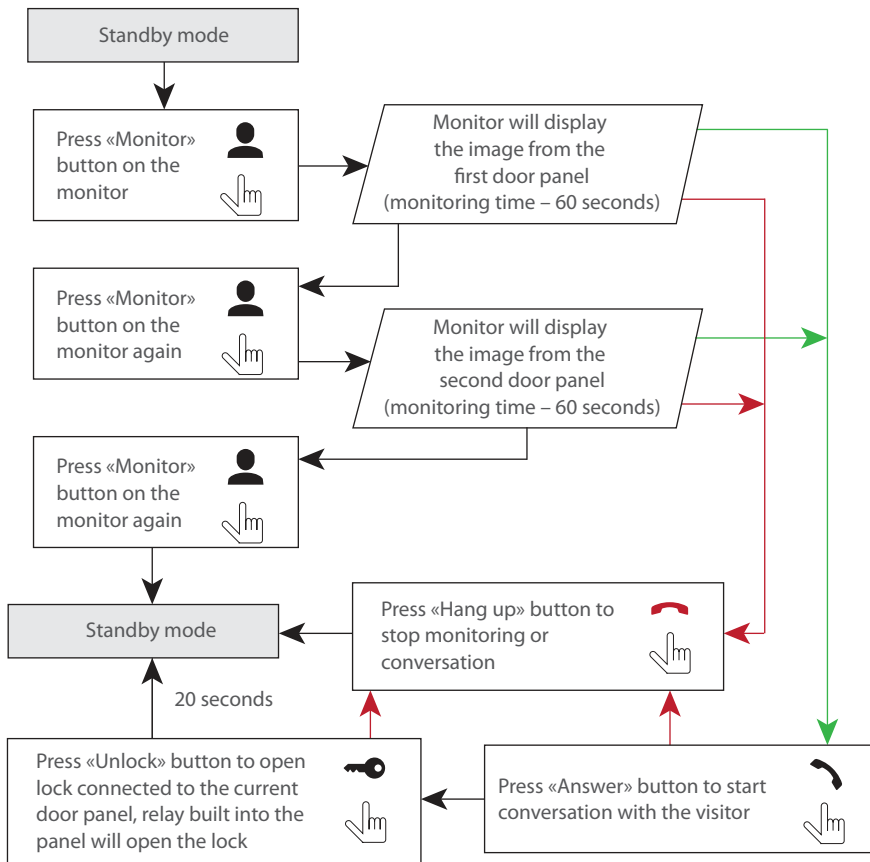

Notes:  
 If someone press call button on the door panel while monitoring is active then the image from this door panel appears on the monitor screen and call melody starts. Press «Answer» button to start conversation.

6. Limited warranty

Manufacturer guarantees product normal functioning during the warranty period if the user keeps all safety instructions described in that manual.

Warranty period is 12 months from the moment of the product purchasing (warranty period could be extended up to 24 months or more, depending on the local regulations).

Warranty period allows user to make guarantee repair in cases when normal functioning of the product was violated by the fault of manufacturer and the user has not offend transporting, installation and working conditions.

This limited warranty does not cover any damage to the product that results from improper installation, accident, abuse, misuse, natural disaster, insufficient or excessive electrical supply, abnormal mechanical or environmental conditions, or any unauthorized disassembly, repair or modification.

Warranty void in such cases:

- the product was damaged by the fault of the customer;
- the product wasn't properly installed according recommendations from the manual;
- the sticker on the backside of the product was broken;
- the product was not used for its intended function.

This limited warranty covers only repair, replacement, refund or credit for defective products, as provided above. Manufacturer is not liable for, and does not cover under warranty, any damages or losses of any kind whatsoever resulting from loss of, damage to, or corruption of, content or data or any costs associated with determining the source of system problems or removing, servicing or installing products.

This warranty excludes third party software, connected equipment or stored data. Manufacturer is therefore not liable for any losses or damage attributable to third party software, connected equipment or stored data.

In the event a product has been discontinued, manufacturer shall either repair the product, offer to replace it with a comparable product or provide a refund at the lesser of the purchase price or the product's current value.

Repaired or replacement products will continue to be covered by this limited warranty for the remainder of the original warranty term.